

# Copyright 2021

I Formation - Selected Youth Football Plays by Coach Parker - **Version 1.01182021**

Copyright 2021 - Stephen Christopher Parker  
All Rights Reserved

Published by:

Stephen Christopher Parker  
4941 Thorn Hollow Drive  
Ft. Worth, TX 76244

[CoachParker.org](http://CoachParker.org)



# Blocking Vocabulary

Many youth football coaches have heard GOD, GOO, MOMA, and GOL, but what do they mean? They refer to blocking rules. Here are a few rule blocking terms that you should include in your offensive blocking vocabulary.

- ❖ **GAP** – refers to space between the linemen. GAP rule is block GAP toward the ball or play side for Center.
- ❖ **On or Over or Outside** – On refers to the defensive linemen who are head up or outside shade of o-lineman, Over refers to Linebackers – Outside Gap
- ❖ **Down** – Continue blocking the next man on the line.
- ❖ **Downfield** – Block down field
- ❖ **GOD** – Gap ON Down or Downfield or near Defender
- ❖ **GOLD / GODLI** – Gap On LB Near Defender or Down / Gap On Down Inside LB
- ❖ **GOO** – Gap On Over or Outside (Use for pass blocking and backside TE with a hinge block)
- ❖ **GOOP** – Gap On Outside Pass (this is my main pass blocking call)
- ❖ **ION / IOD** – Inside Gap, On / Inside Gap Defender or Down
- ❖ **MOMA** – Man on Man Away ( Good Center Rule)
- ❖ **Linebacker** – block the most dangerous Linebacker
- ❖ **GOL** – Gap, ON, Linebacker
- ❖ **Inside or Outside** – block d-linemen in the GAP or On the next lineman to his inside or block outside gap and over for outside call.
- ❖ **Fill** – Tells lineman to block any defender in pulling lineman’s area
- ❖ **SAB** – Severe Angle Blocking – track angle blocking scheme at 30% angle on play side either in or out. “Larry” = Left & “Roger” = Right
- ❖ **Track** – blocking a zone or area not a single defender – like on a railroad track anything gets in way then block
- ❖ **JAW** – Inside SAB Track Call – Simplified GOD call.
- ❖ **BB@#** - Butt to Butt Split block @ called hole - Split Block @ 6 hole = BB@6

GOD is probably the most popular youth football blocking rule. If you are not using blocking rules with your youth offensive line, you should develop a set of simple rules today. For younger players I use JAW which is a simplified GOD inside track blocking call.

# Hole Numbers, Lanes & Players

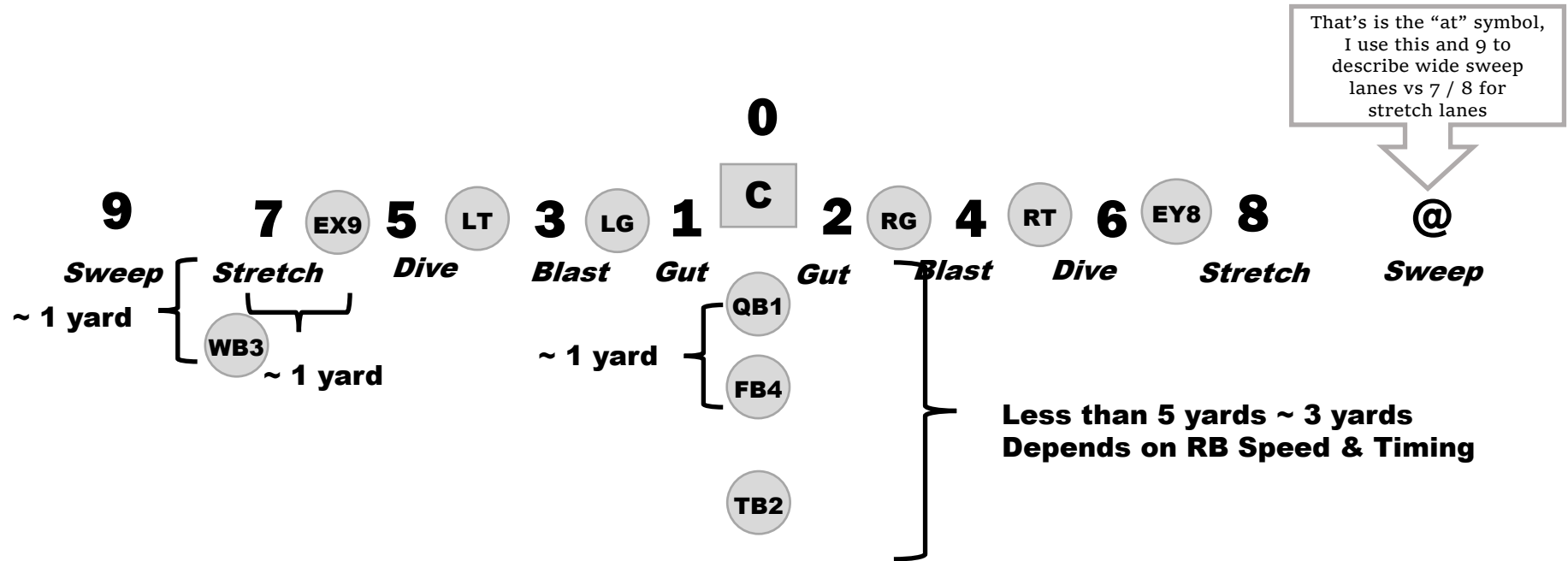

- Hole Numbering
- Running Lane Names
- Player Names / Numbering – Olineman  
Numbers are inside Gap Number RG = #2
- O-Line Gap Splits 0 to 2' – prefer 6" to 1'
- RB Depth & Spacing

# IWL 3Dmo QB 10 Sneak Wedge

**Blocking Call: Wedge Block**

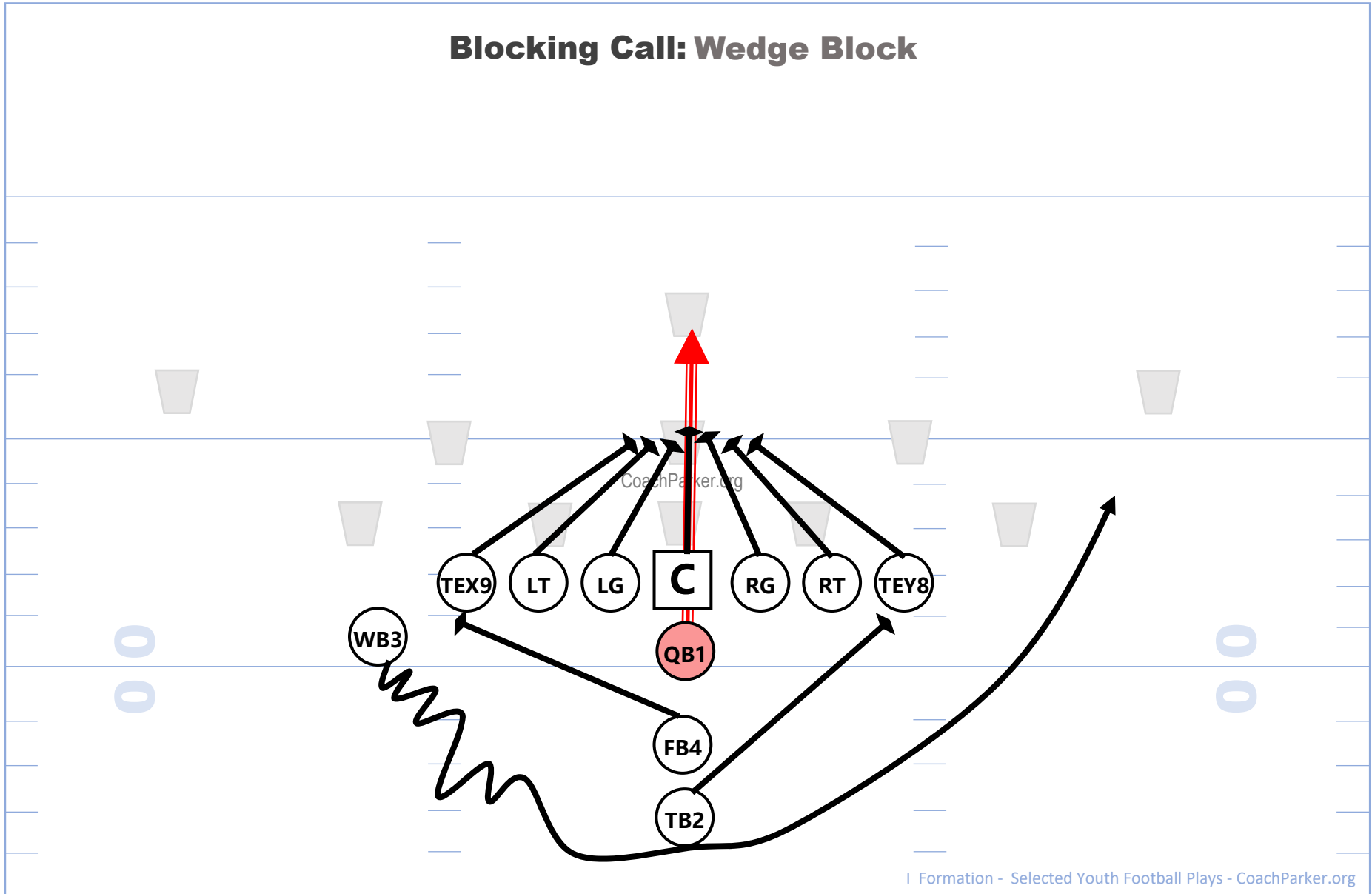

# IWR Spin 3Crkmo 4ZB QB 17 BootLeg

Blocking Call: Larry

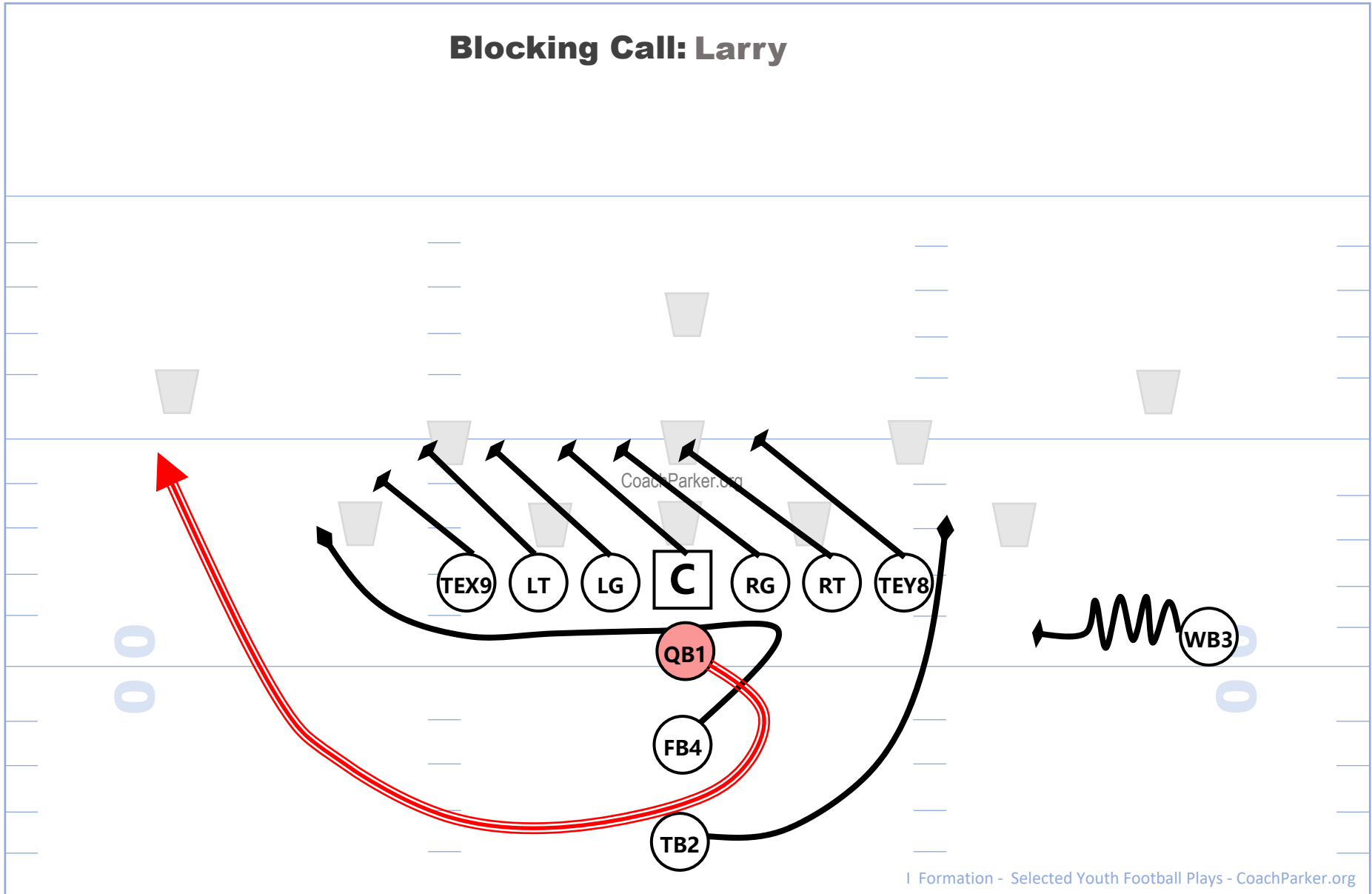

# IWL Spin FB 44 Counter Blast

**Blocking Call: BB@4**

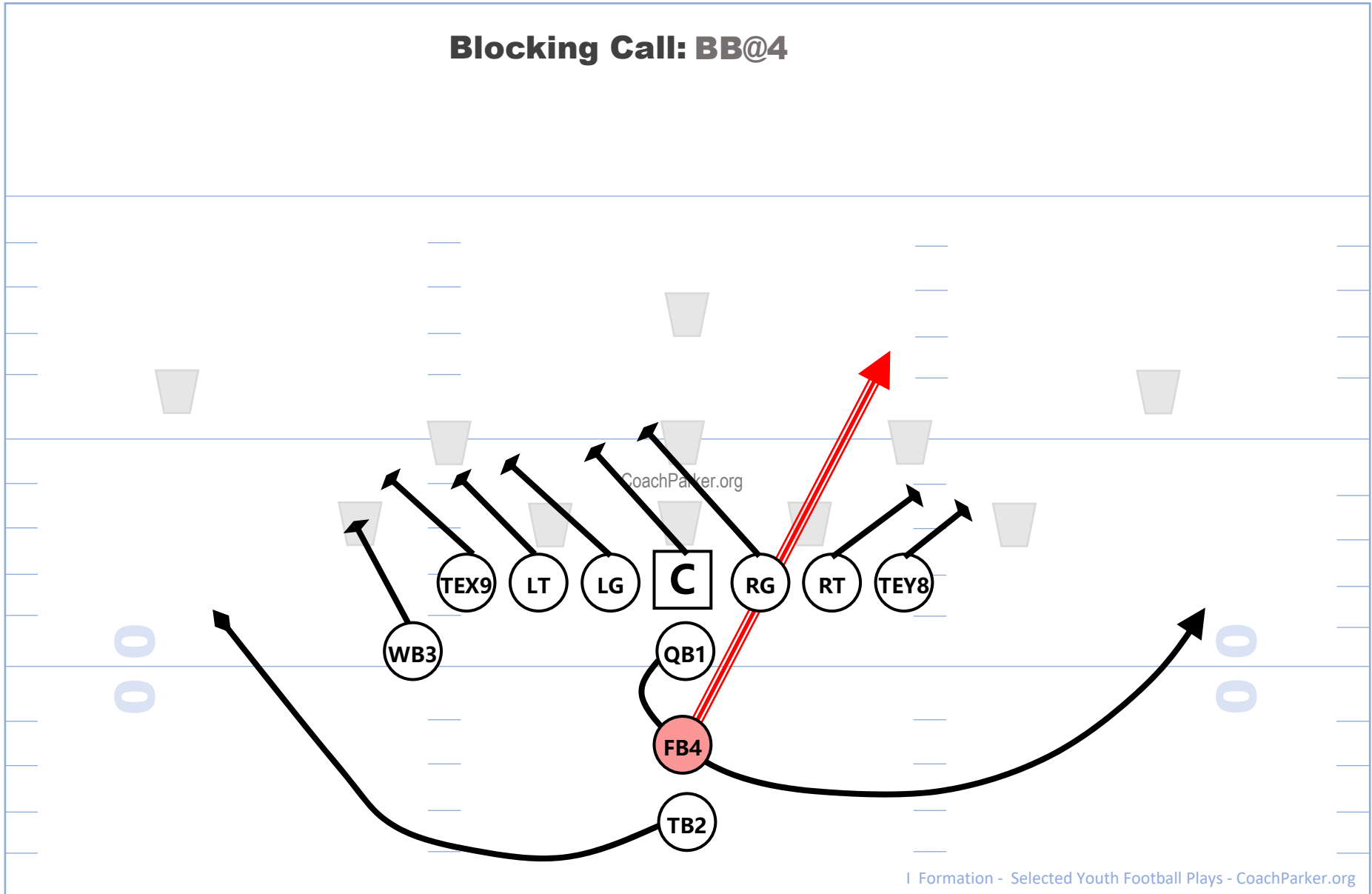

# IWideL Quick TB 22 Lead Gut

Blocking Call: BB@2

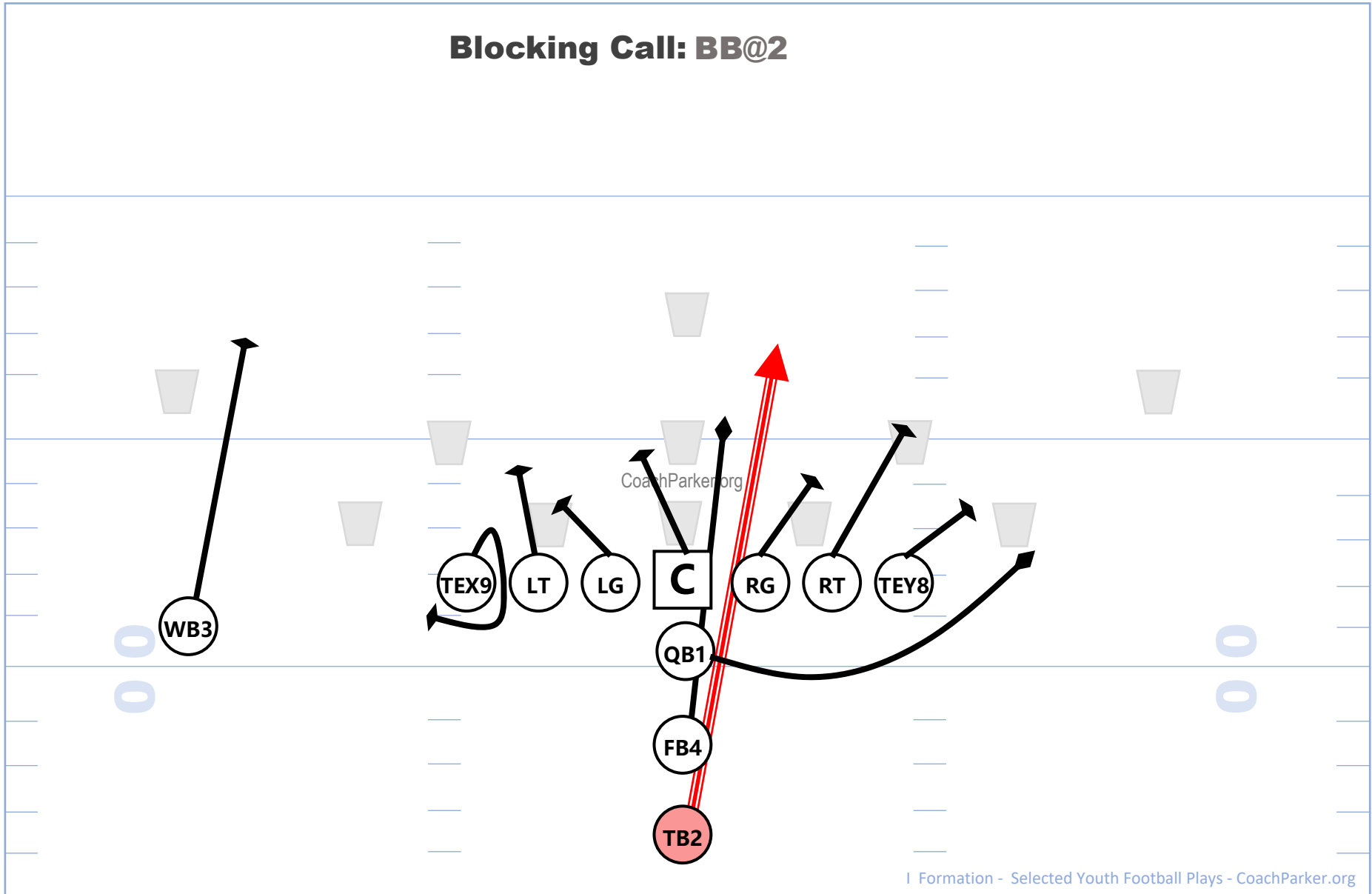

# IWideR Spin 3CrakMo 2@ Toss Sweep

**Blocking Call: Roger**

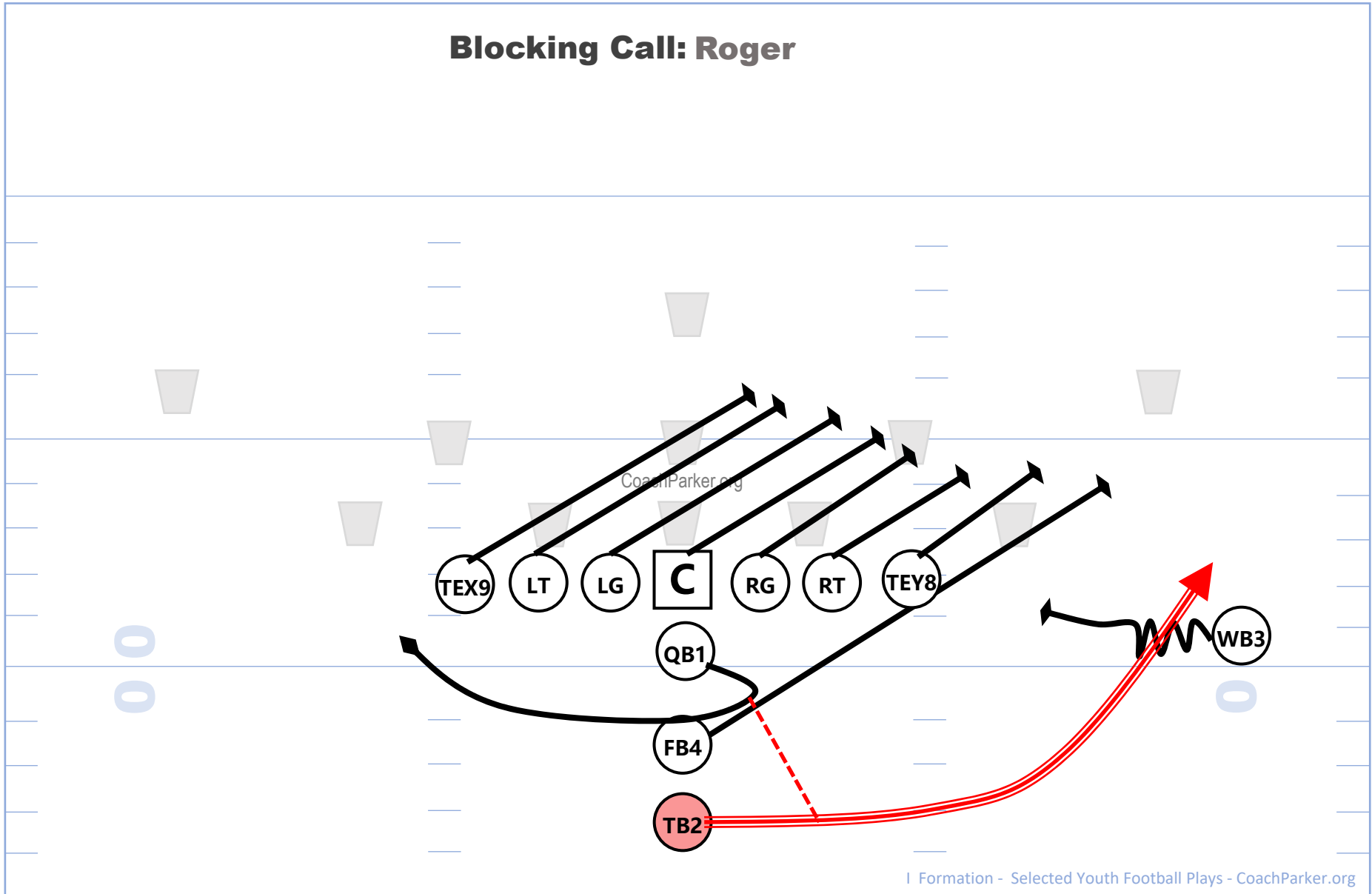



# IWL QK WB3 36 Counter

**Blocking Call: BB@6 - G-Pull - LB**

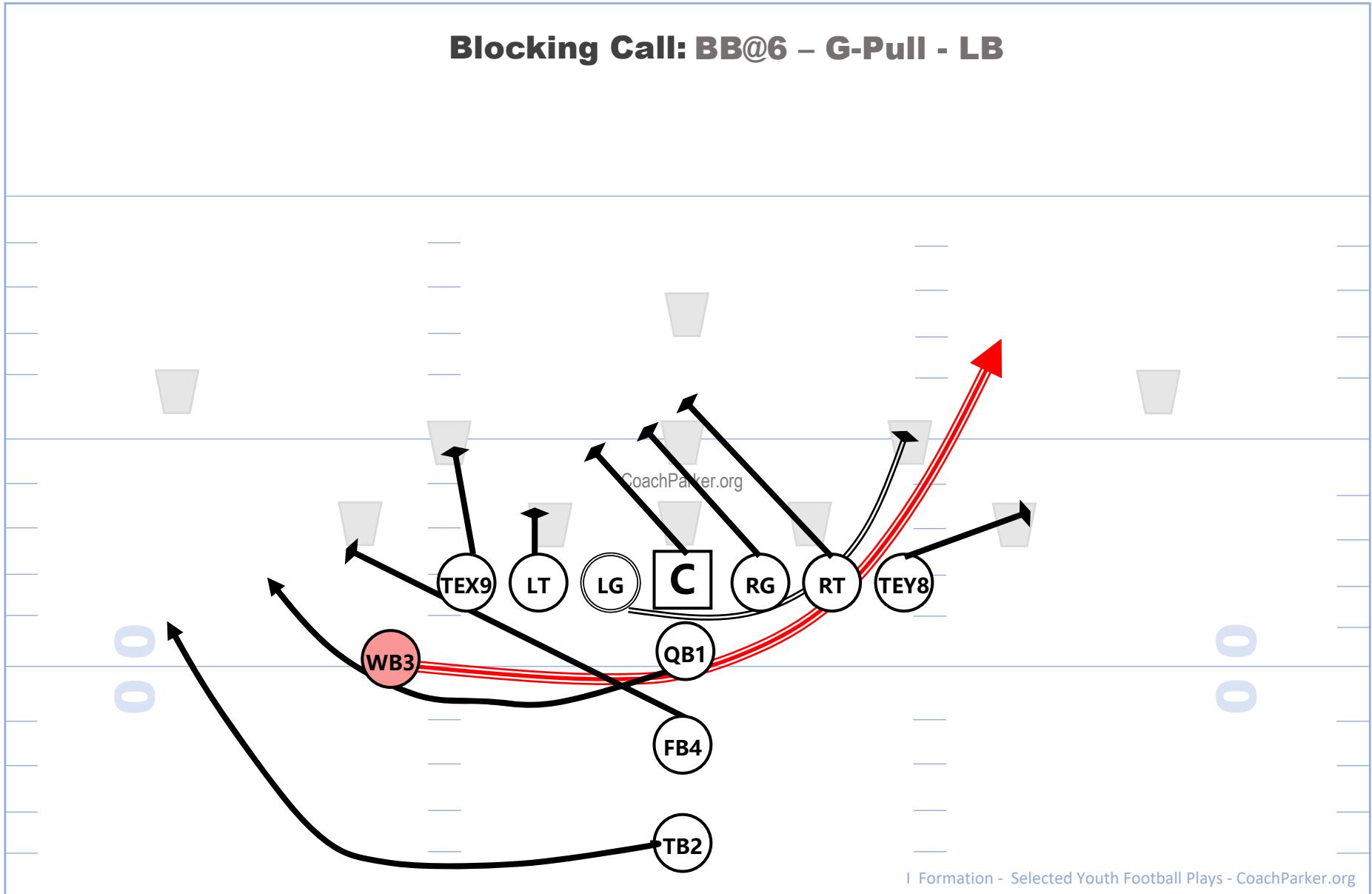

# IWL XY Pop Pass

**Blocking Call: GOOP**

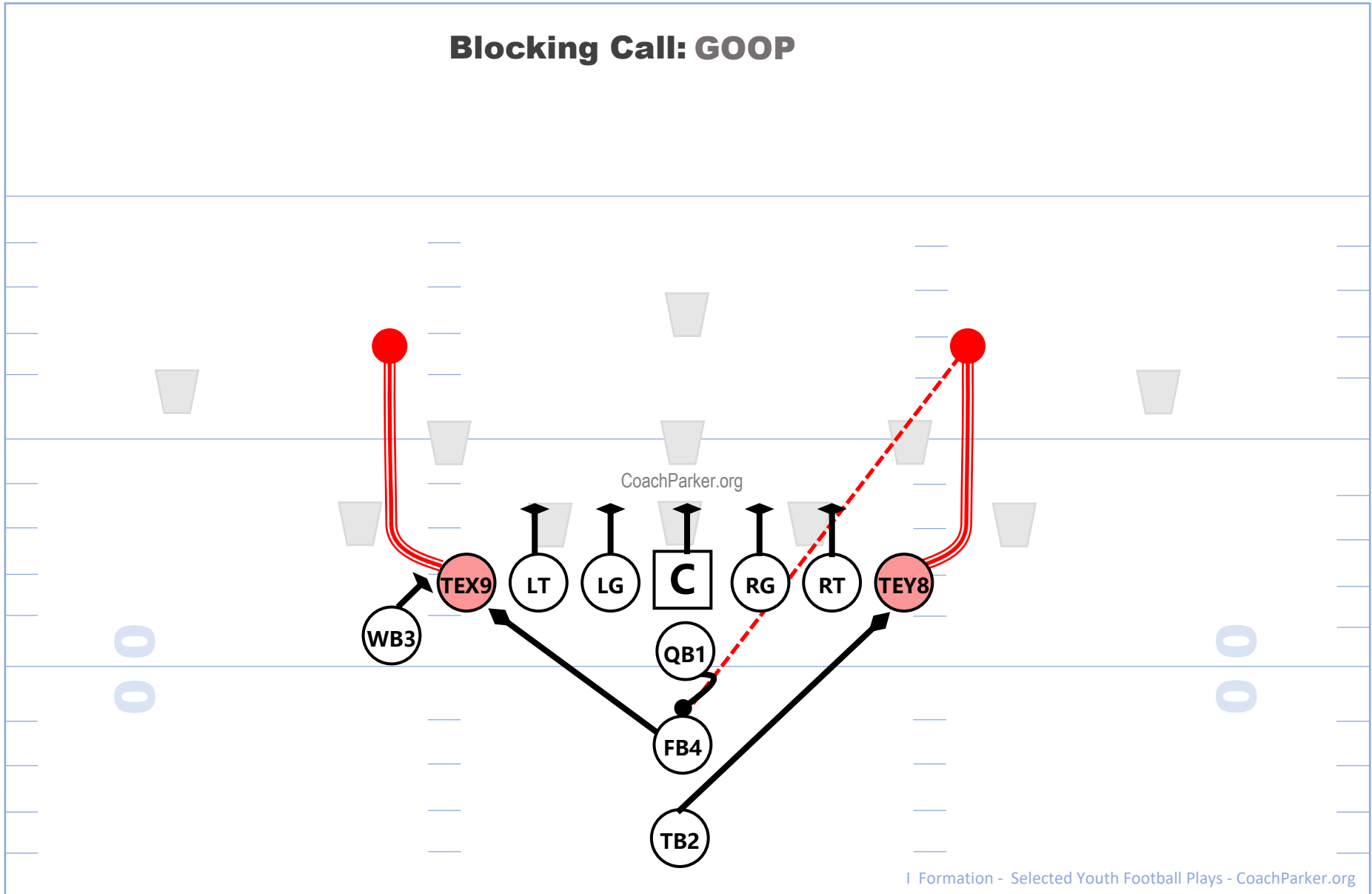

# EyeR Spin Y Split Hook TB Sail Pass

Blocking Call: GOOP

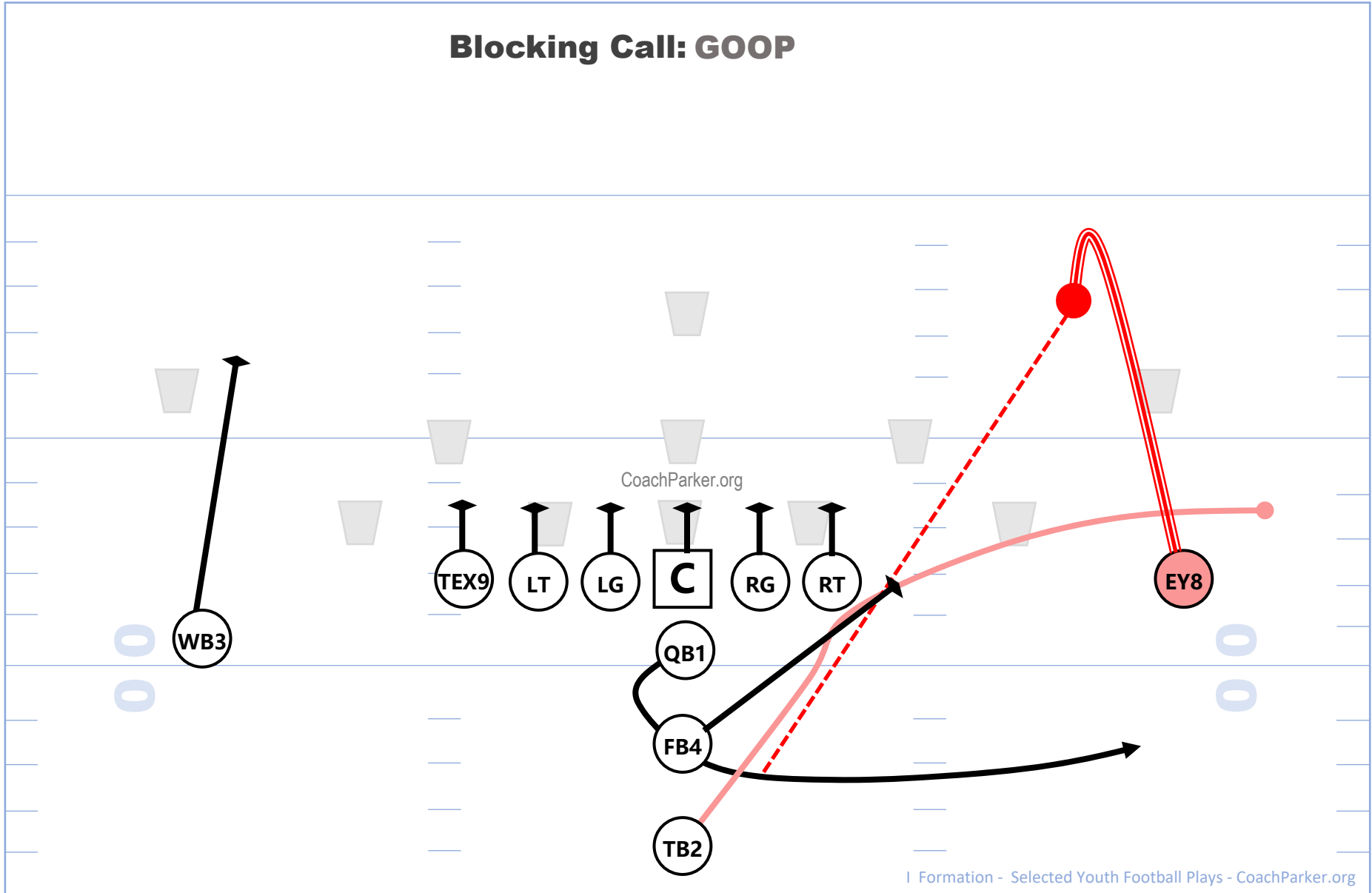

# Pass Route Combos

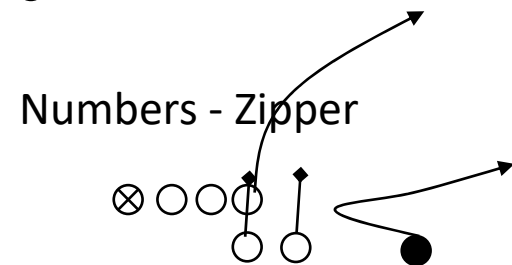
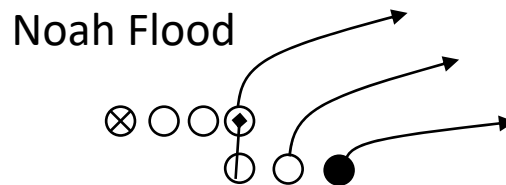
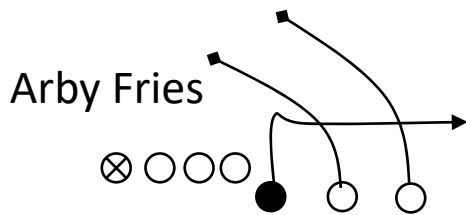
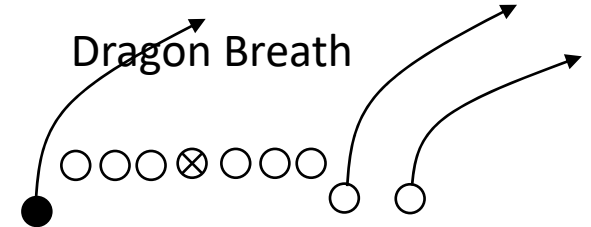
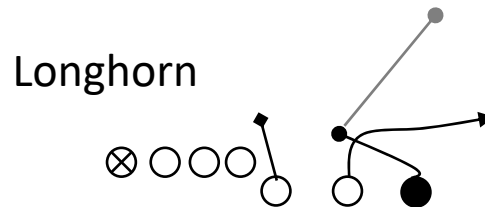
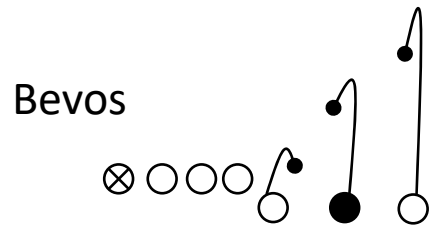
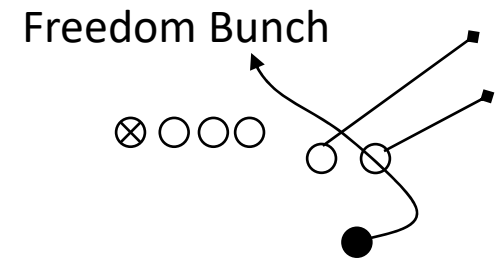
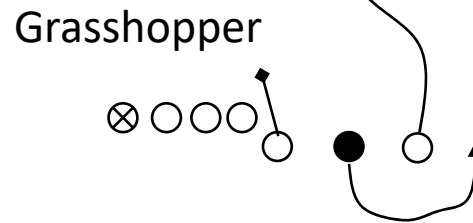
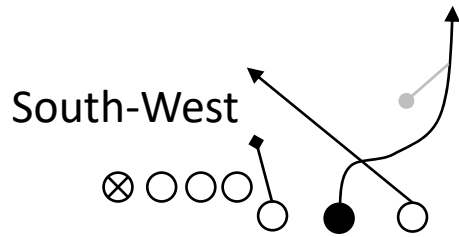
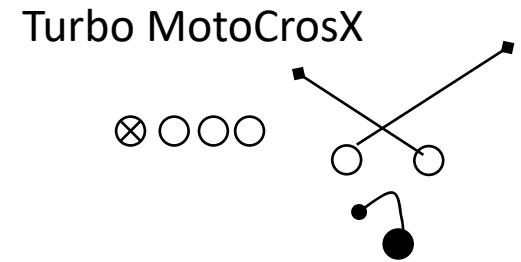
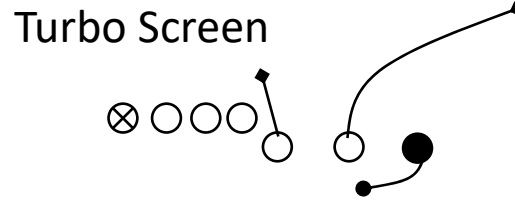
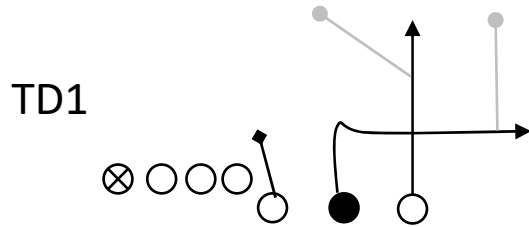

# Formations 2

## Traditional I (Lt) – “EyeL”

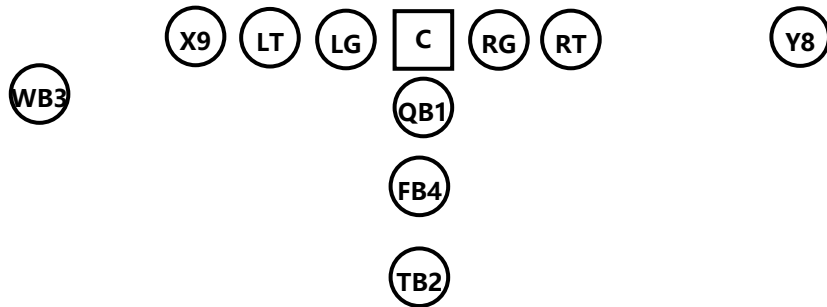

## Split Right

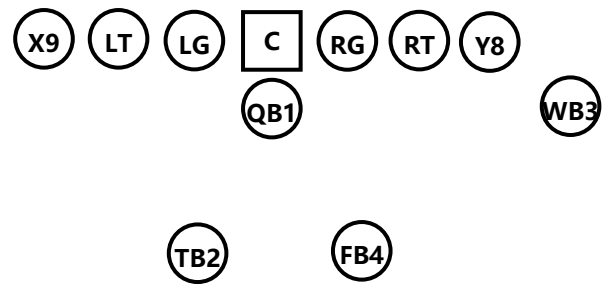

## Power I Right

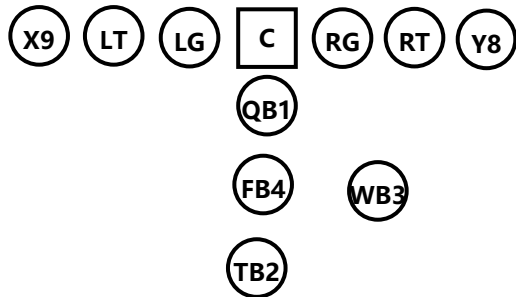

## Split Rt Slot R

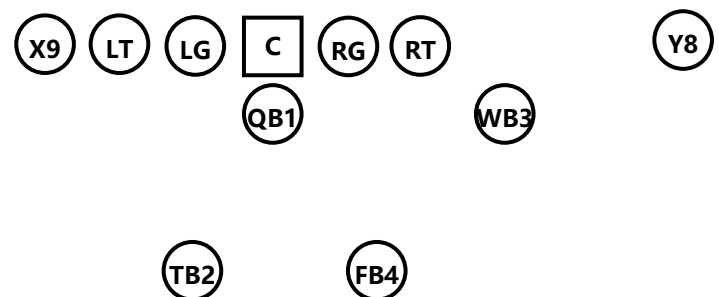

# Pie Big Left 27 Power Lead

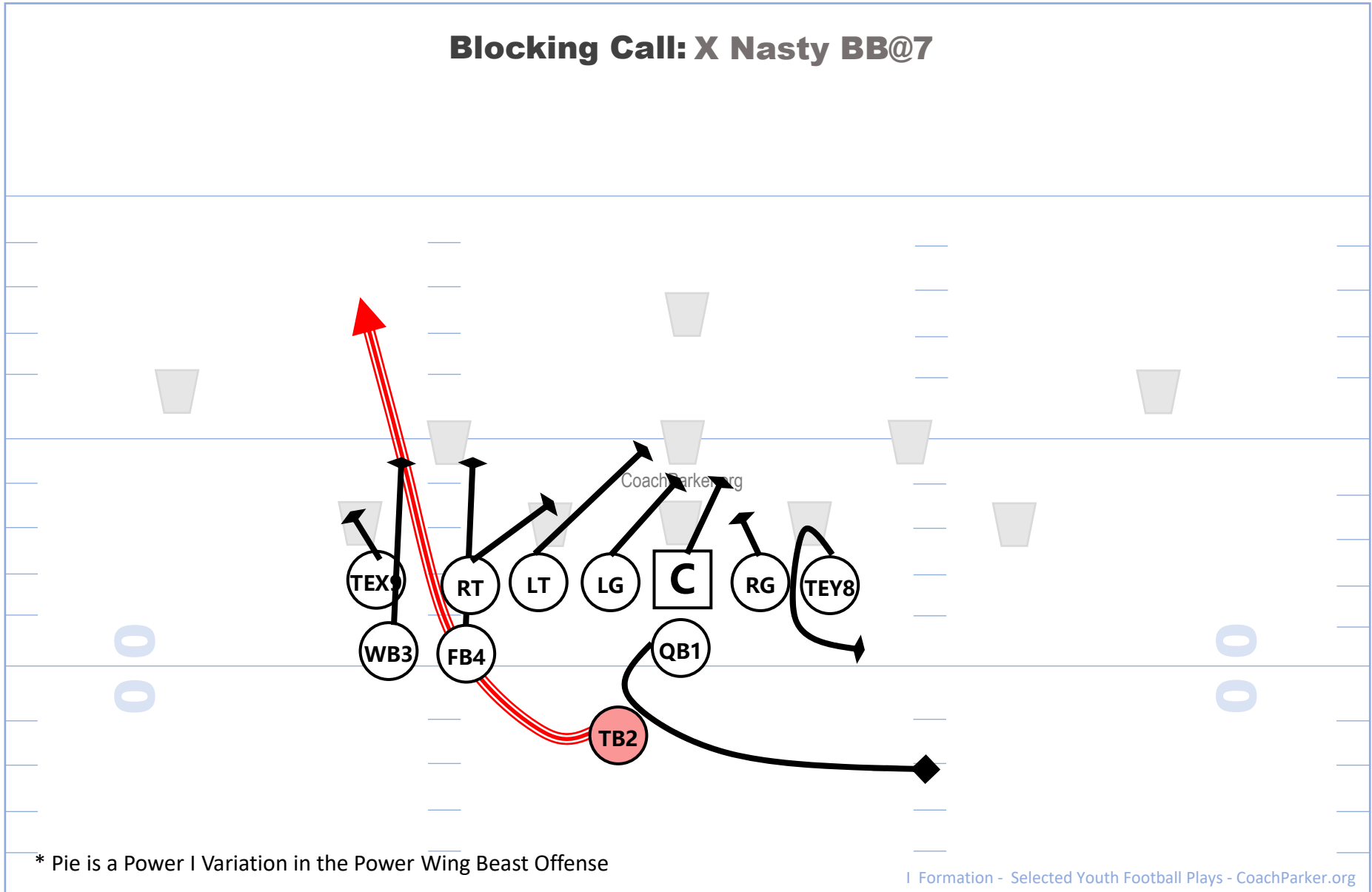

# Other eBooks by Coach Parker

@ <https://coachparker.org/youth-football-playbooks-store/>

- 1) Power Wing Beast Offense
- 2) Pirate 62 Multi 8 Youth Football Defense
- 3) Wildcat Spread Offense
- 4) Coach Parker's Youth Football Drills
- 5) JAWS Coaching Youth Football O-line Blocking
- 6) Wolfpack 7on7 Plays
- 7) 8 Man Beast Offense Plays
- 8) O-line One Pager Practice Play
- 9) Wishbone Formation – Selected Youth Football Plays

